

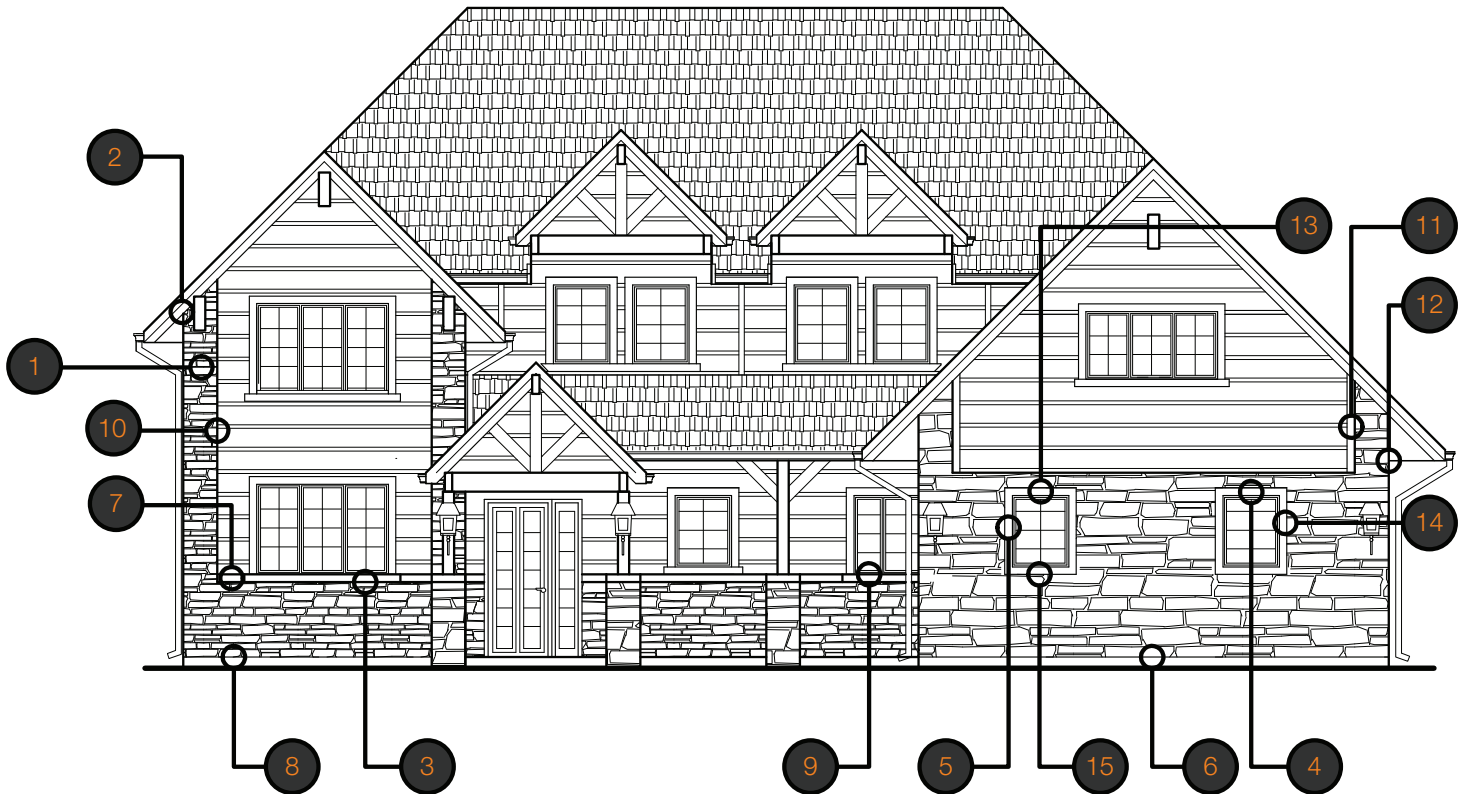

# DETAIL DRAWINGS



## Installation over Z-Girts

- 1. Brick Detail
- 2. Parapet Detail
- 3. Pre-Cast Sill Detail
- 4. Window Head Detail
- 5. Window Jamb Detail
- 6. Wall Base Detail

## Installation over Sheathing and Wood Studs

- 7. Pre-Cast Sill Detail
- 8. Wall Base Detail
- 9. Pre-Cast Sill Detail - Window
- 10. EIFS Detail
- 11. Adjacent Finish Detail
- 12. Soffit Detail
- 13. Window Head Detail
- 14. Window Jamb Detail
- 15. Window Sill Detail



# BRICK DETAIL

## INSTALLATION OVER Z-GIRTS

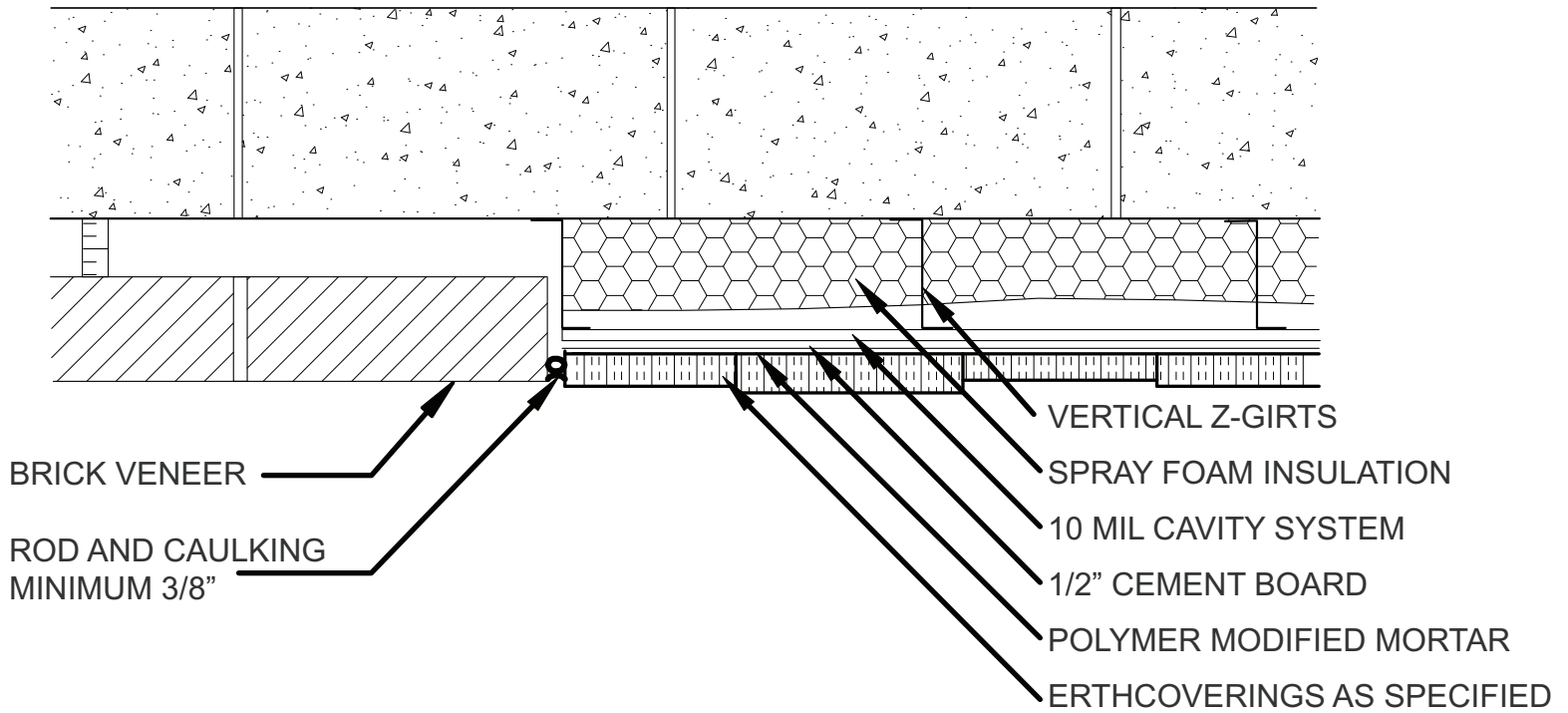



# PARAPET DETAIL

## INSTALLATION OVER Z-GIRTS

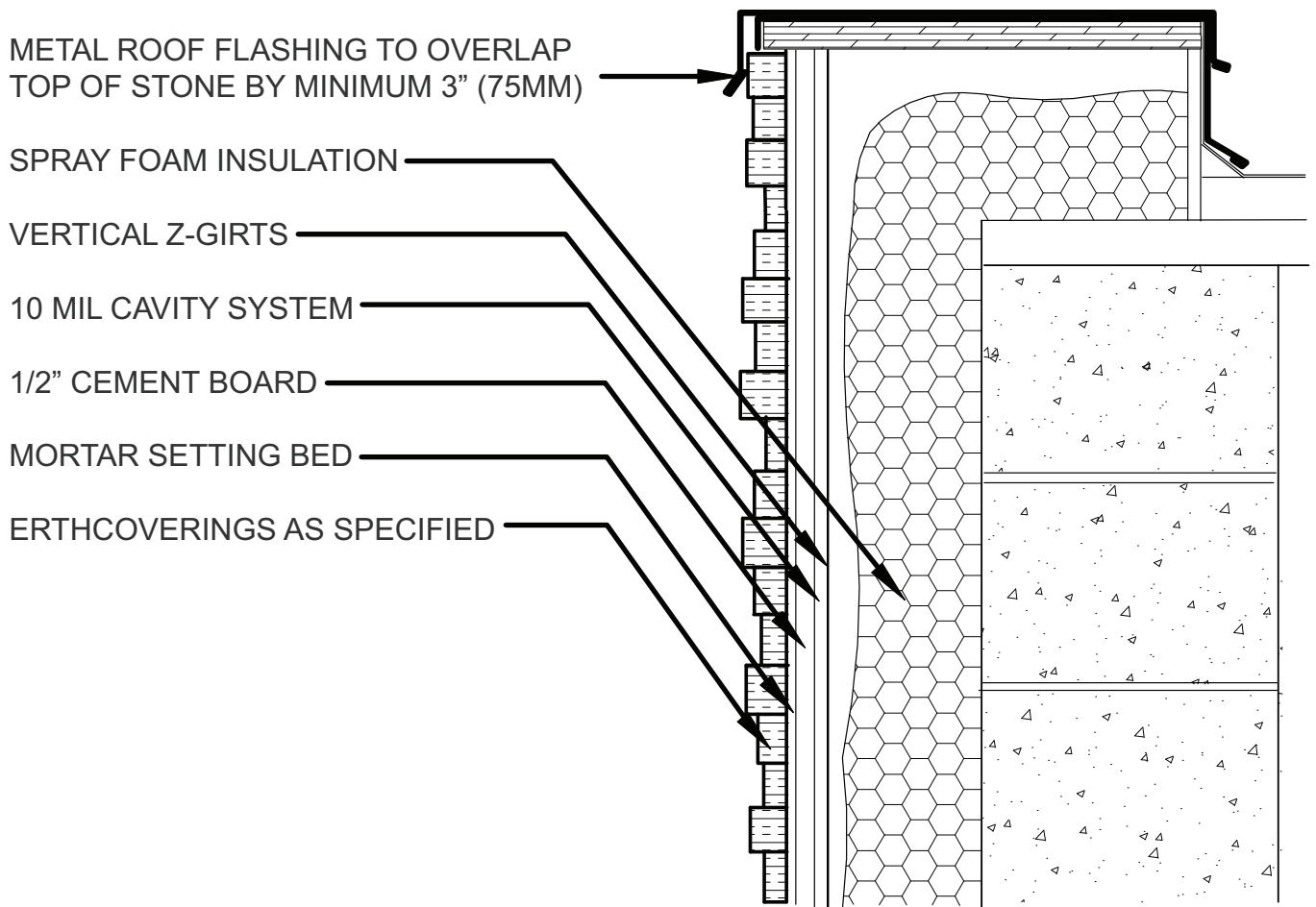



# PRE-CAST SILL DETAIL

## INSTALLATION OVER Z-GIRTS

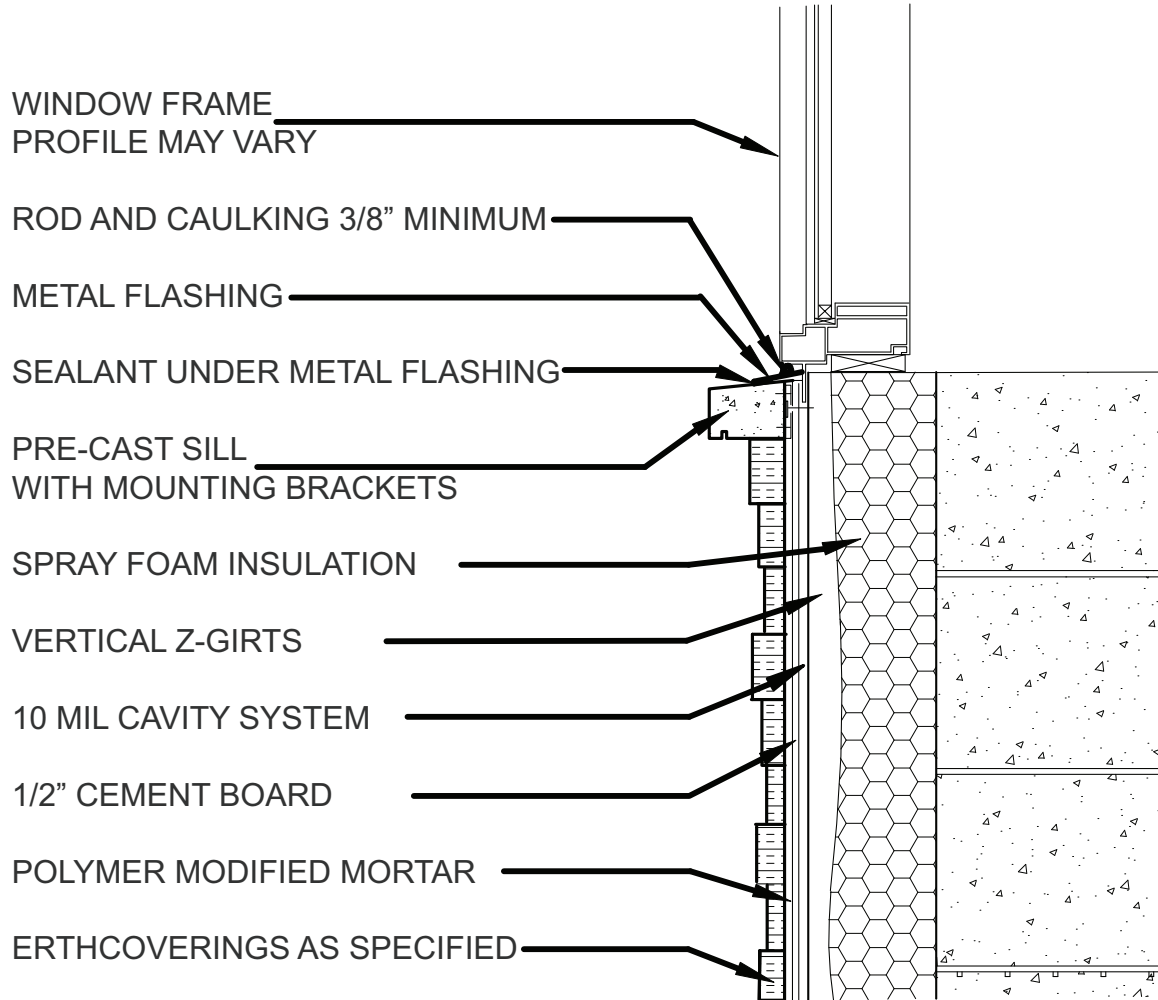



# WINDOW HEAD DETAIL

## INSTALLATION OVER Z-GIRTS

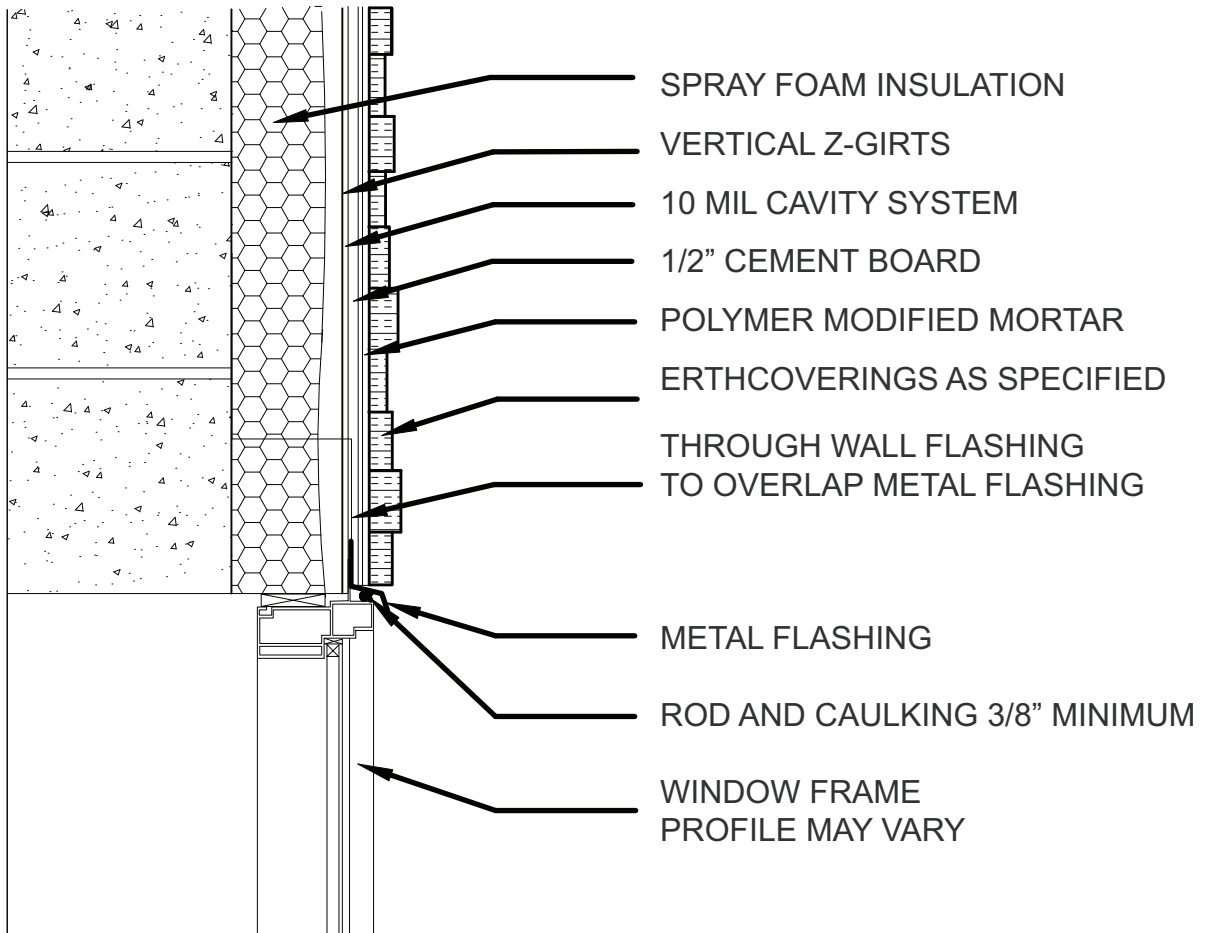



# WINDOW JAMB DETAIL

## INSTALLATION OVER Z-GIRTS

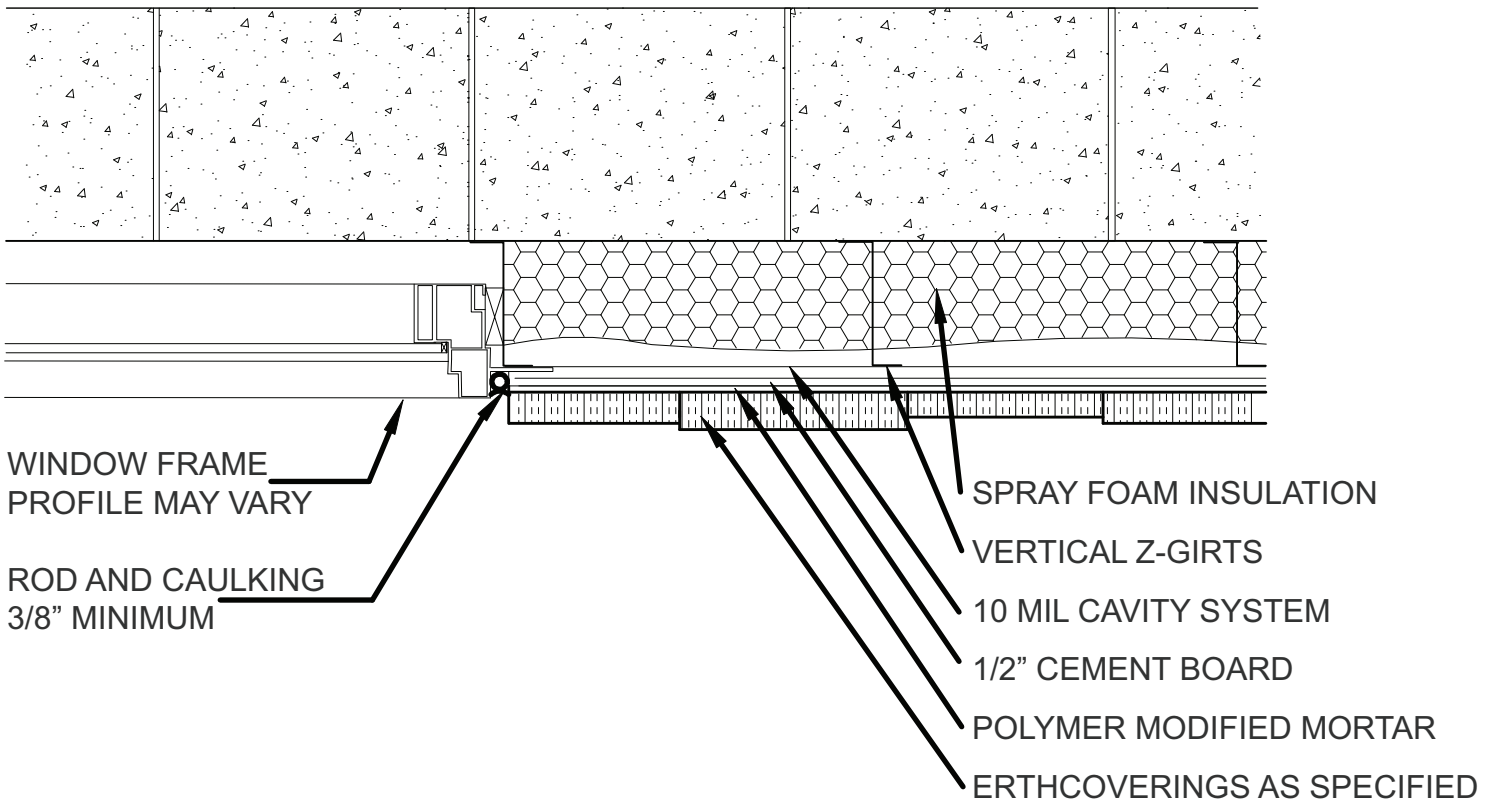



# WALL BASE DETAIL

## INSTALLATION OVER Z-GIRTS

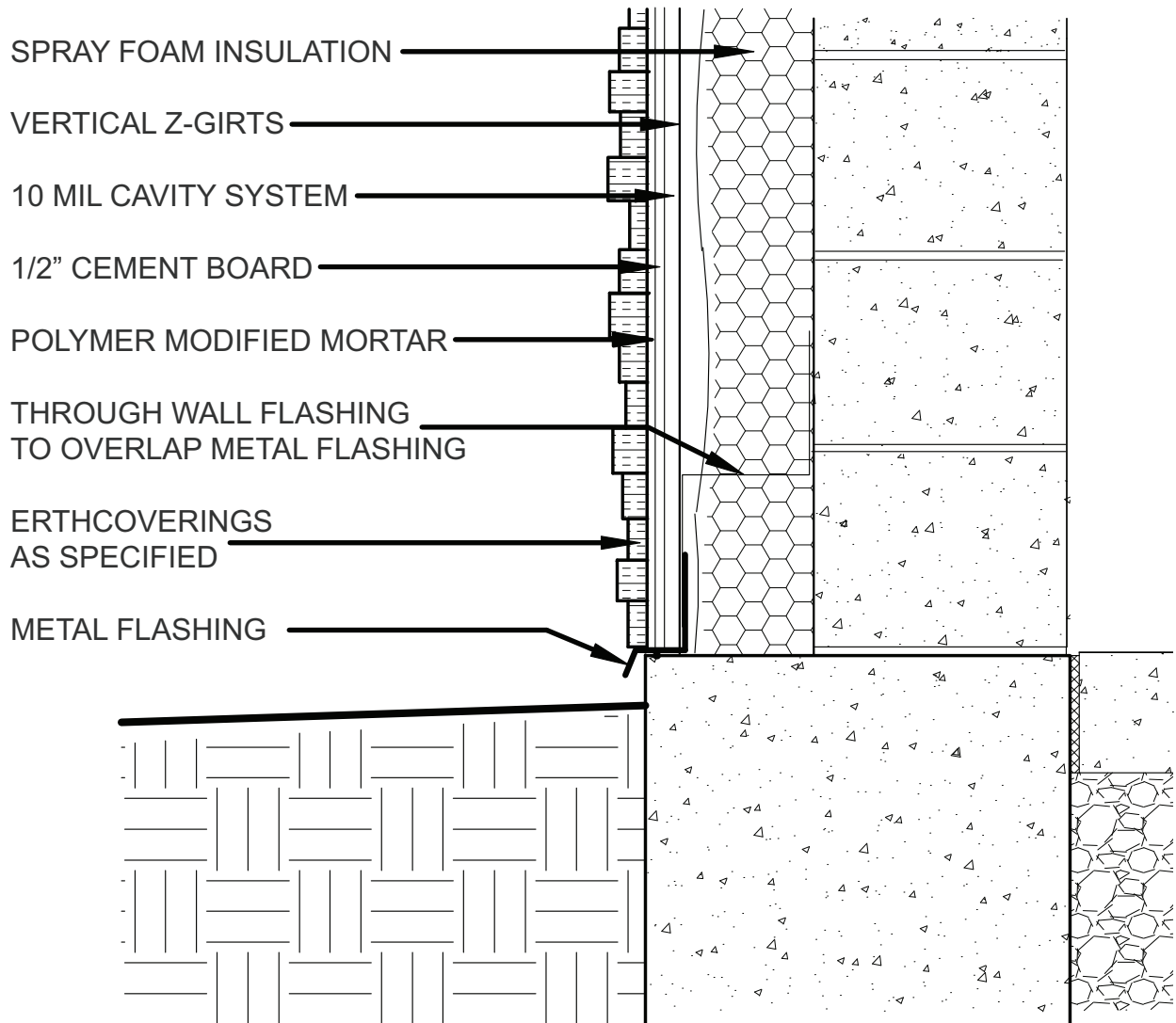



# PRE-CAST SILL DETAIL

INSTALLATION OVER SHEATHING AND WOOD STUDS

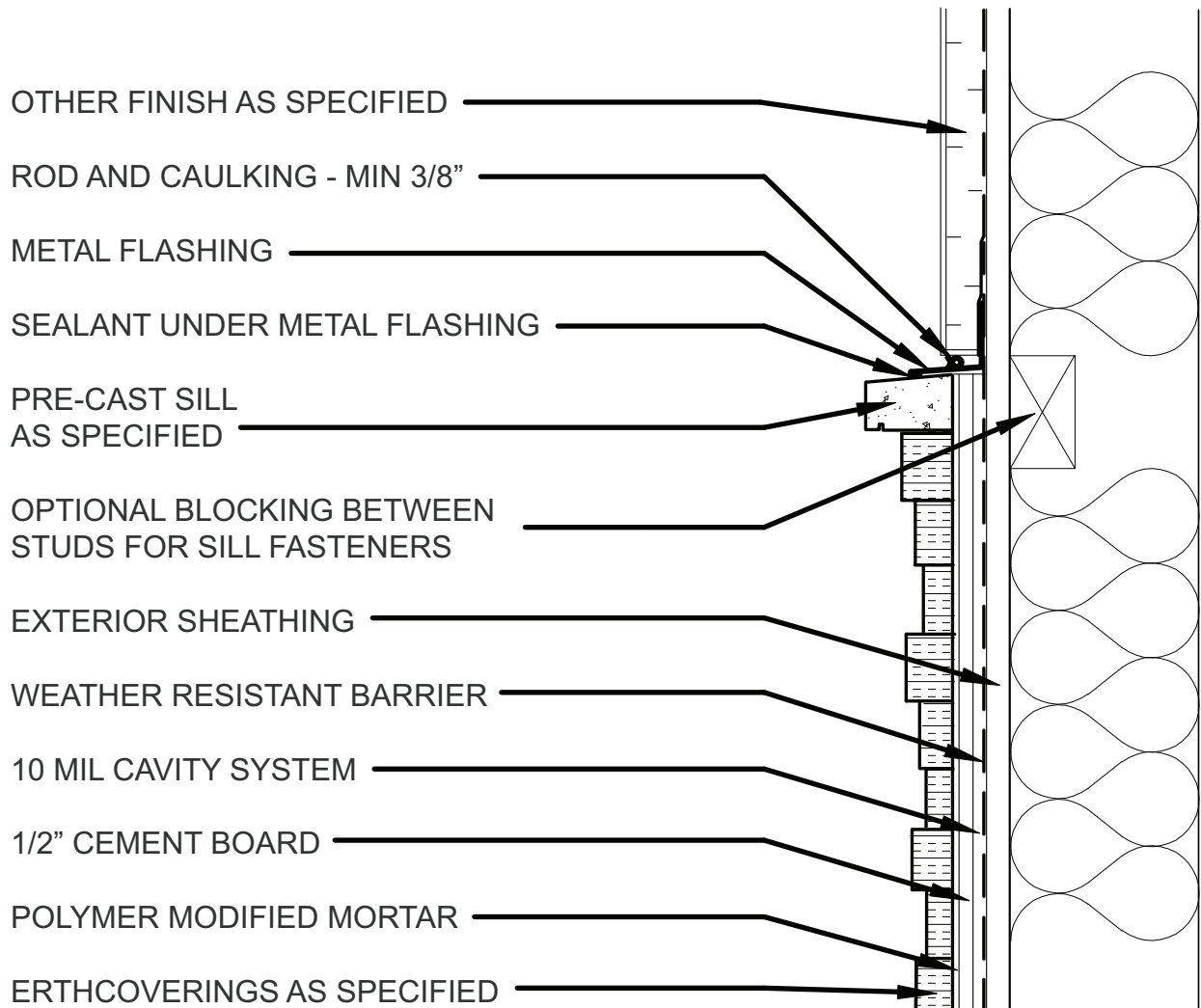





ErthCOVERINGS®

# WALL BASE DETAIL

INSTALLATION OVER SHEATHING AND WOOD STUDS

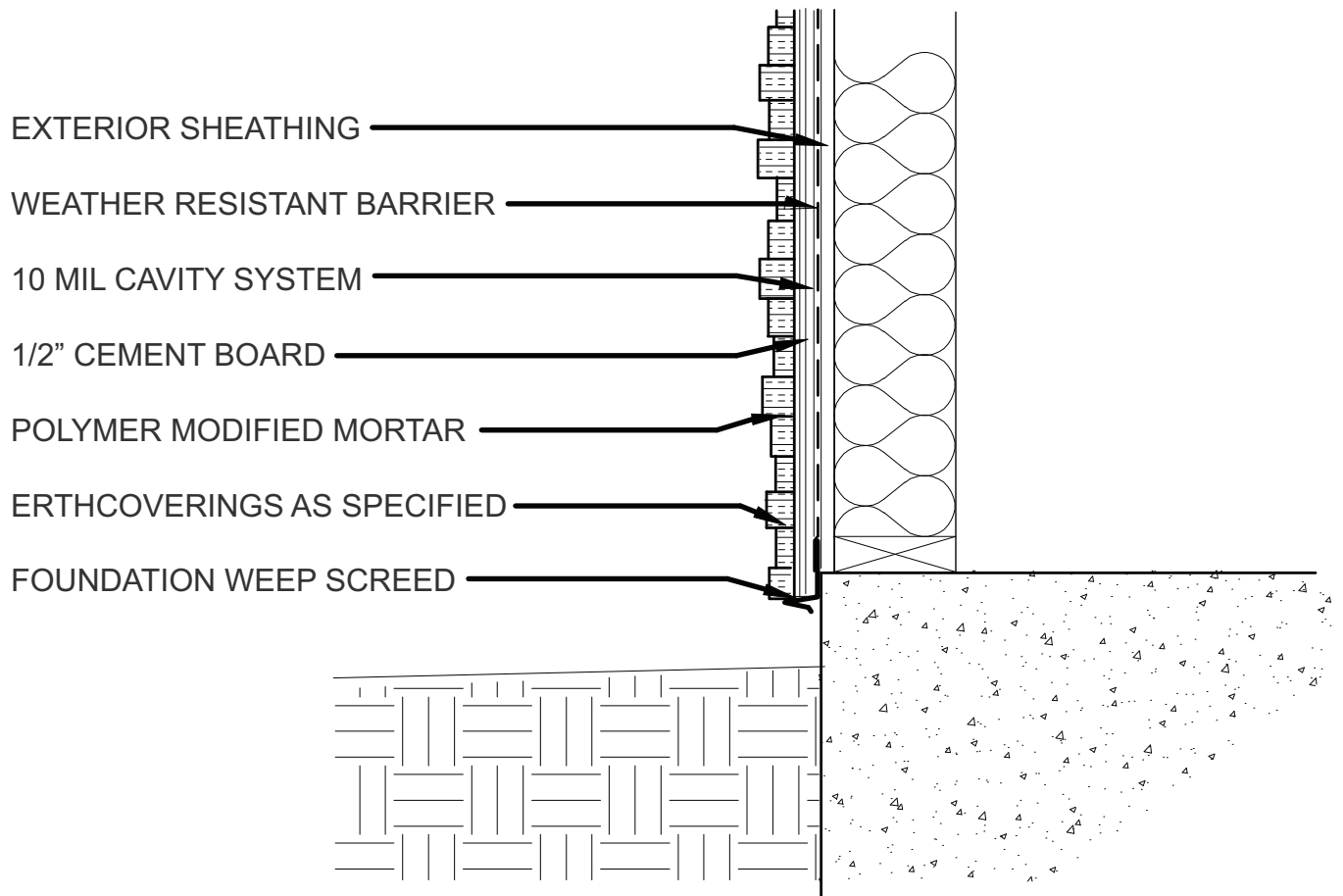



# PRE-CAST SILL DETAIL - WINDOW

INSTALLATION OVER SHEATHING AND WOOD STUDS

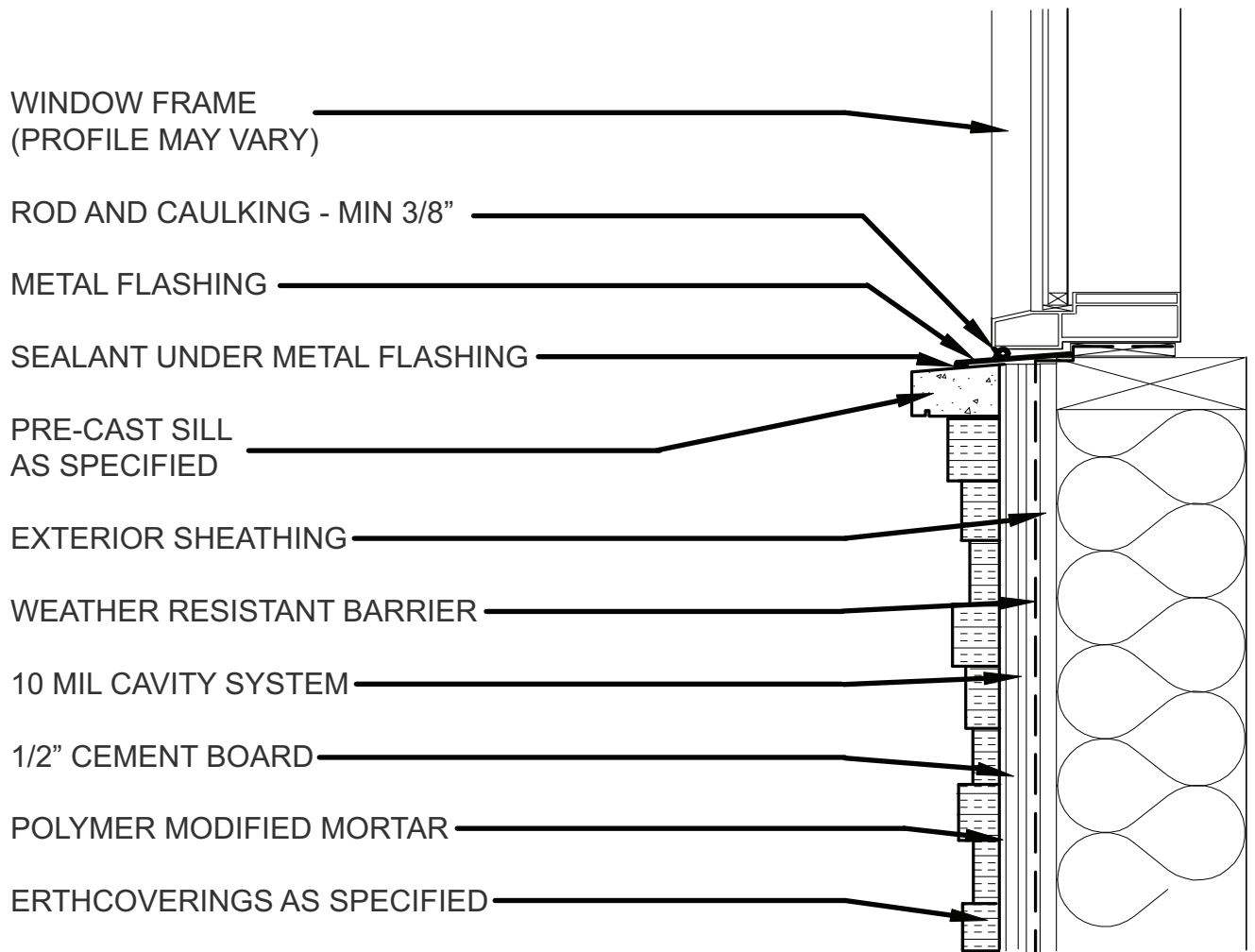



# EIFS DETAIL

## INSTALLATION OVER SHEATHING AND WOOD STUDS

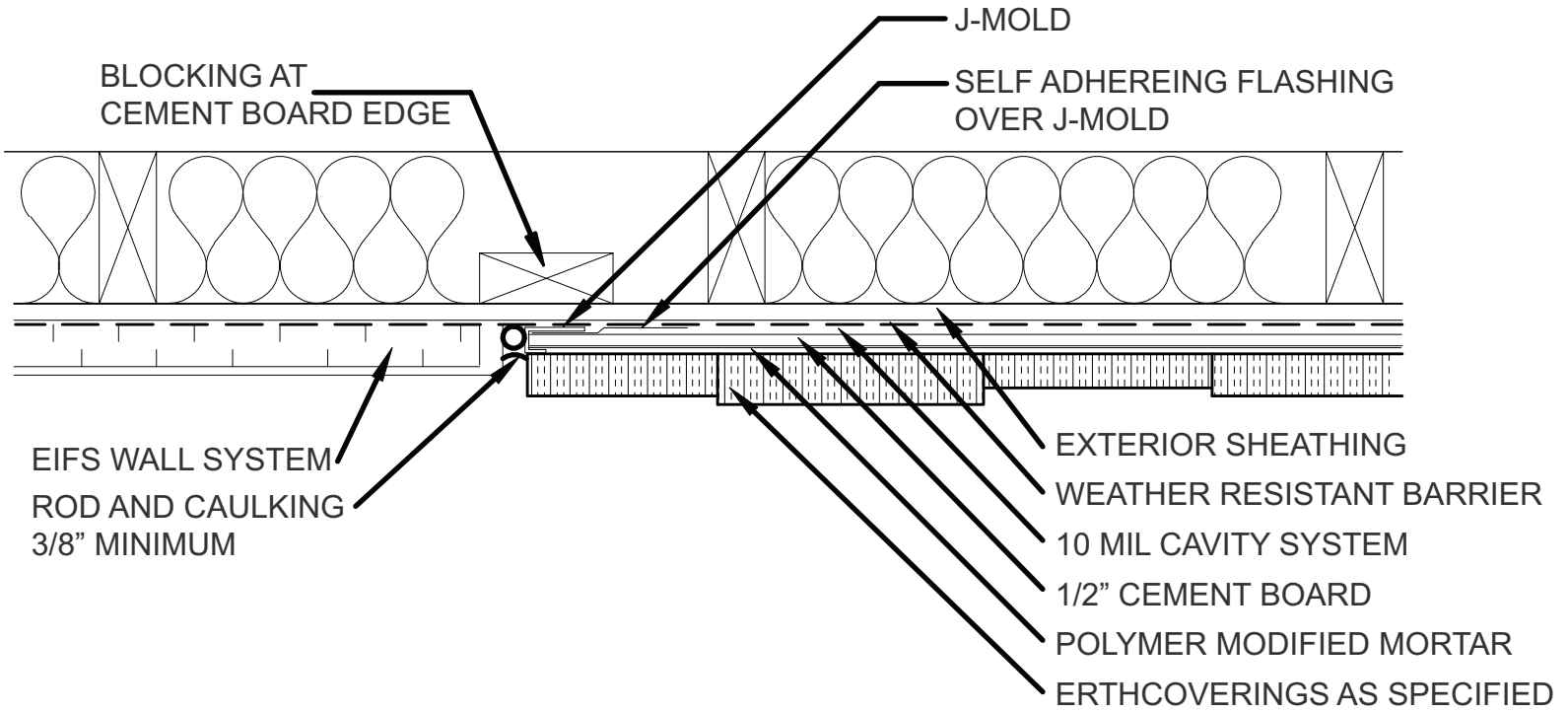



# ADJACENT FINISH DETAIL

INSTALLATION OVER SHEATHING AND WOOD STUDS

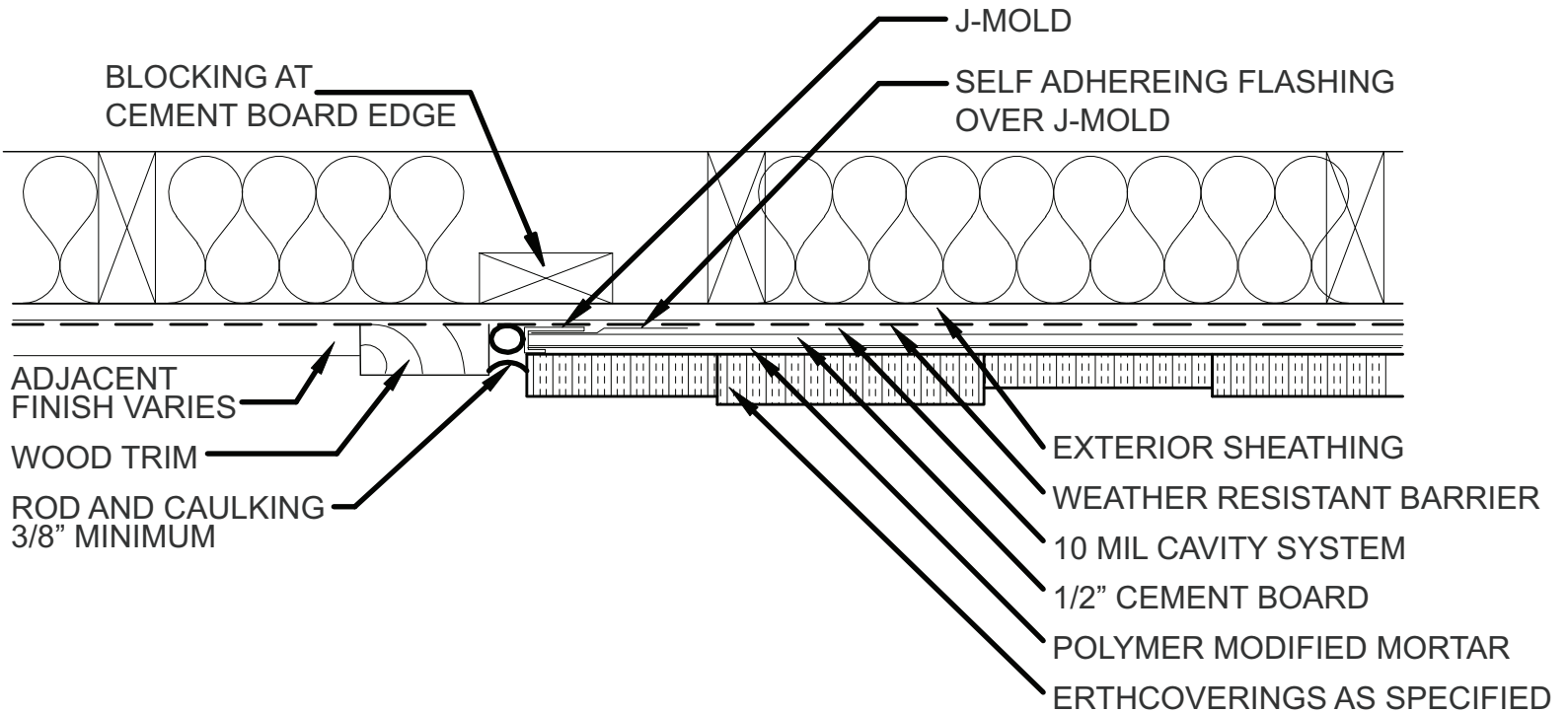



# SOFFIT DETAIL

INSTALLATION OVER SHEATHING AND WOOD STUDS

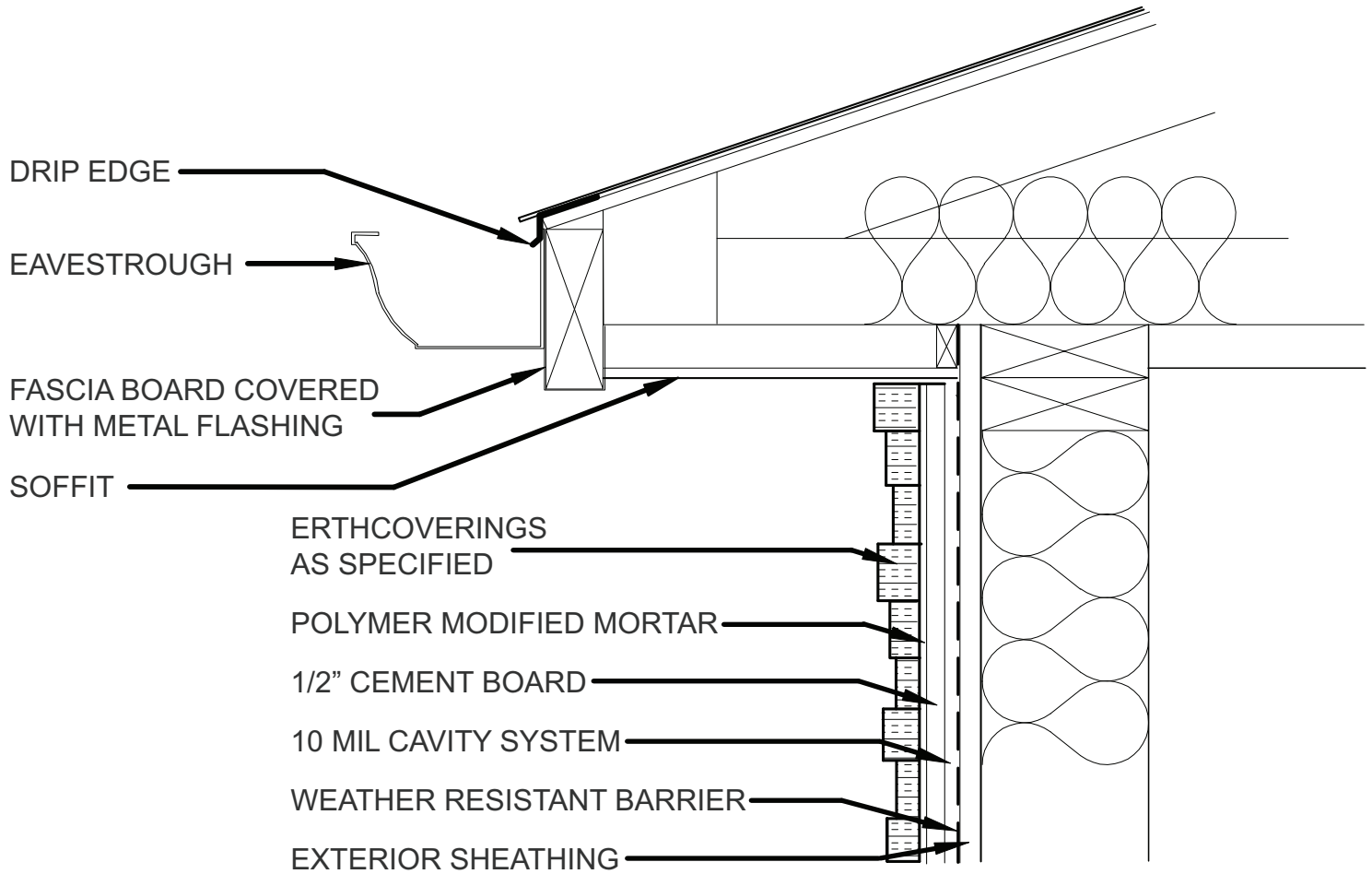



# WINDOW HEAD DETAIL

INSTALLATION OVER SHEATHING AND WOOD STUDS

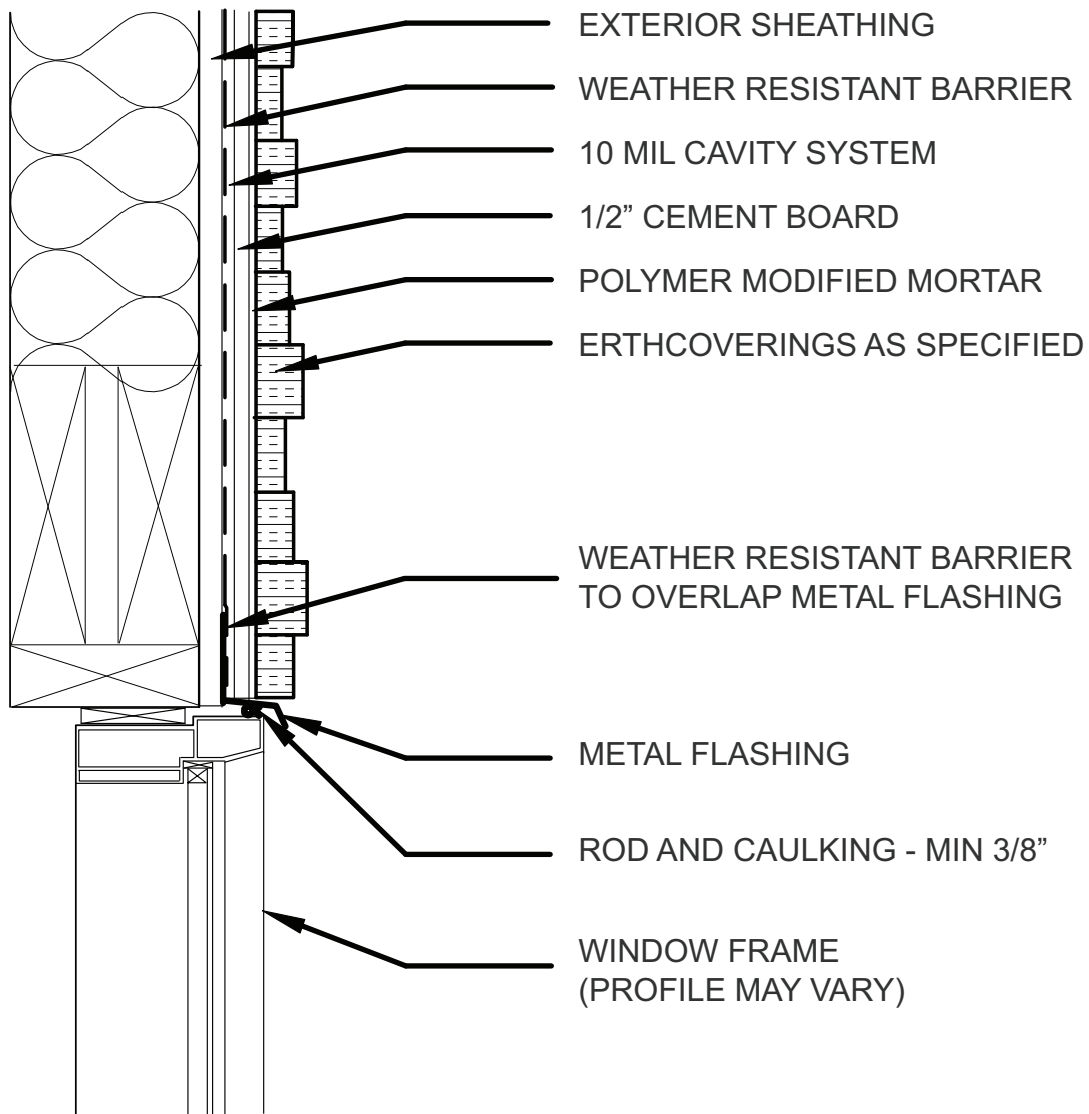



# WINDOW JAMB DETAIL

INSTALLATION OVER SHEATHING AND WOOD STUDS

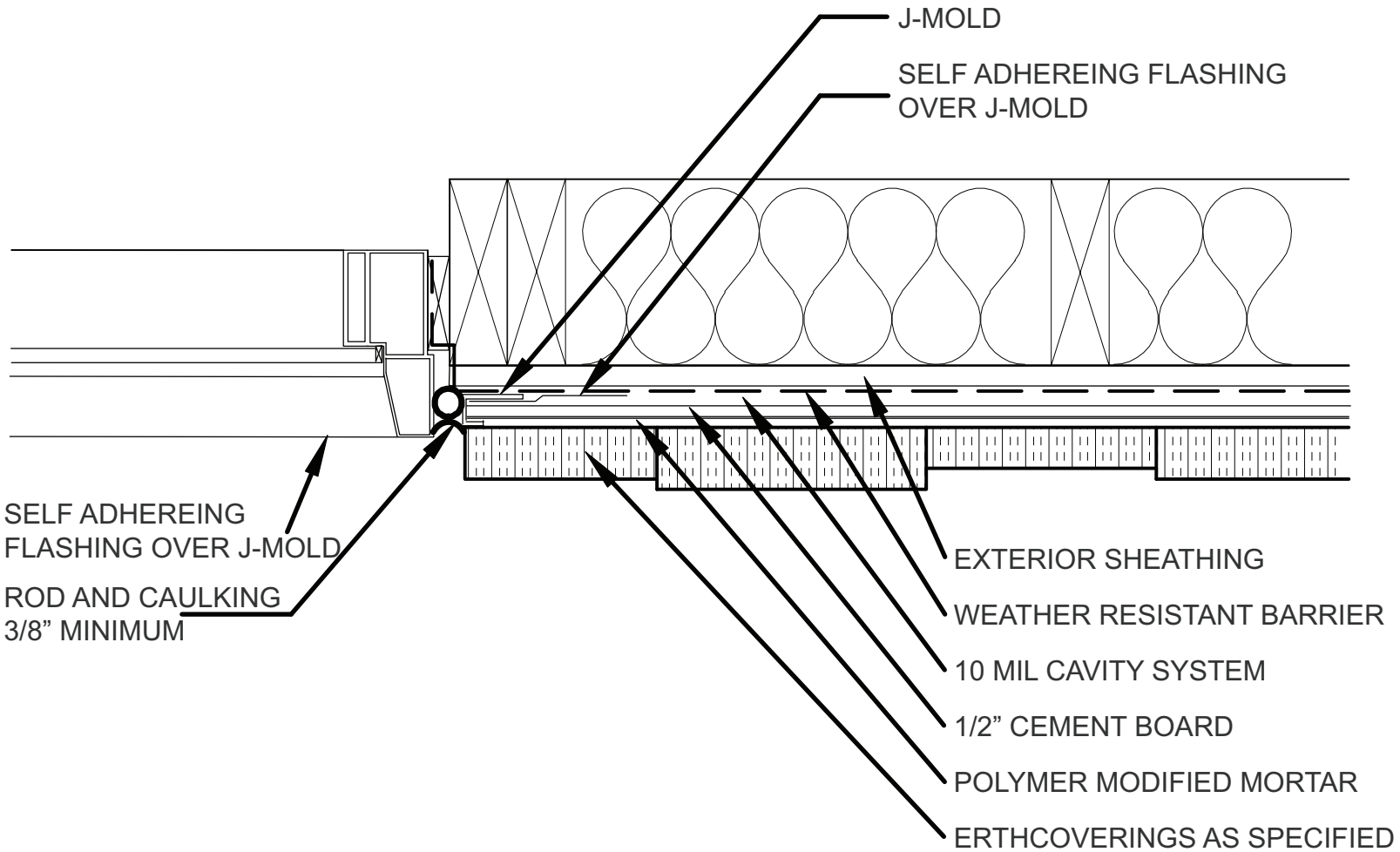



# WINDOW SILL DETAIL

INSTALLATION OVER SHEATHING AND WOOD STUDS

